

Keysight Technologies N5531S Measuring Receiver

Technical Overview



The Keysight Technologies, Inc. N5531S measuring receiver system provides metrology/calibration customers with an ideal tool for calibrating signal generators and step attenuators up to 50 GHz. It enables customers to use off-the-shelf, general-purpose instruments to perform measurements with the most stringent requirements for measurement uncertainty, repeatability, and traceability in metrology and calibration environments.

The N5531S is comprised of a PSA high-performance spectrum analyzer installed with Option 233, a P-Series or EPM Series power meter, and a sensor module with single-input connection up to 50 GHz. By placing the receiver measurements and controls directly into the PSA, it eliminates the need for an external PC – providing a more compact measuring receiver system.

Key measurements include:

- Frequency counter
- Absolute RF power
- Tuned RF level
- TRFL with tracking
- AM depth
- FM deviation
- Φ M deviation
- Modulation rate
- Modulation distortion
- Modulation SINAD
- Audio frequency
- Audio AC level
- Audio distortion
- Audio SINAD
- Auto carrier triggering
- CCITT filters

Flexible, Compact Package with Maximum Frequency and Power Level Coverage

While building on the tradition of excellence established by Keysight's previous measuring receivers, the N5531S takes a more flexible approach by designing a system based on standard test instruments. It combines the PSA Series high performance spectrum analyzer with a precision P-Series or EPM Series power meter and specially designed sensor module to achieve the best possible measurement accuracy. This design provides a number of distinct advantages:

- The outstanding performance of the PSA Series spectrum analyzer and P-Series or EPM Series power meters provide superior performance specifications to meet or exceed the most challenging requirements of the metrology/calibration applications.
- The wide frequency coverage of the PSA Series spectrum analyzer enables you to make measurements up to 50 GHz without the need for external downconverters and local oscillators used by previous measuring receivers. This saves both your budget and valuable lab space, and also helps to eliminate operator errors due to complexity of the measurement system.
- The excellent sensitivity of the N5531S in tuned RF level (TRFL) measurements allows the user to calibrate step attenuators with the widest dynamic range within the required measurement uncertainty and speed.

- The modulation and optional audio analysis capability of the N5531S, based on the latest digital signal processing technologies, enables users to perform modulated or audio signal characterizations with superior measurement accuracy.
- In addition to a measuring receiver, you also have a high performance spectrum analyzer and power meter for general-purpose usage throughout your lab, effectively stretching your test equipment budget.
- Use equipment you already own. Owners of a PSA spectrum analyzer or P-Series power meter can purchase the additional elements needed to build up a complete N5531S system. The Keysight EPM/EPM-P Series power meter can also be used in the system but requires a LAN/GPIB gateway, such as Keysight E5810A. Since the N5531S performance specifications are derived from that of the individual instruments, no additional system calibration or verification is needed.

“Easy-to-Use” User Interfaces Simplify Instrument Usage and System Control

The measuring receiver personality (Option 233) built into the PSA enables users to set the measurement parameters and to initiate the measurement via the PSA's front panel. One-button pressing can switch between the measuring receiver mode with others, such as spectrum analysis mode, easily and quickly. Measurement results are shown on the PSA's display.

The GPIB interface of the PSA allows remote system control through SCPI commands.

While no external PC is required for the measuring receiver to work, the optional PC software offers PC-based graphic user interface and batch operation mode, as well as a COM API-compliant remote user interface. These enhancements increase the user's capability of controlling the system locally and remotely.

Sensor Modules with Single Input Connection Ensure Measurement Integrity

The N5531S system includes a sensor module to provide a single connection to the device under test (DUT) for all RF measurements. Keysight has introduced a new sensor module N5532B which is a direct replacement for its predecessor N5532A. The N5532B sensor module uses an integrated power splitter to provide independent signal paths for RF and power measurements, which ensures your measurement integrity.

Previous generation sensor modules (11722A/11792A) used mechanical switches to accomplish signal separation. By eliminating mechanical moving parts, the N5532B provides better reliability and repeatability. Four versions of the N5532B are available to cover your specific frequency range of interest up to 50 GHz.

This technical overview includes:

- Measurement capabilities
- Self-guided demonstrations and explanations
- Ordering information
- Related literature



Figure 1. N5532B sensor module (Opt 526, the 26.5 GHz version)

- Frequency Counter
Page 8
- RF Power
Page 9
- Tuned RF Level
Page 10
- AM Depth
Page 12
- FM Deviation
Page 14
- PM Deviation
Page 17



- Audio Frequency
Page 19
- Audio AC Level
Page 20
- Audio Distortion
Page 21
- Audio SINAD
Page 22
- CCITT Filter
Page 21
- AM/FM/PM Carrier Trigger
Page 16
- Modulation Rate
Pages 12/15/17
- Modulation Distortion
Pages 12/15/17
- Modulation SINAD
Pages 13/15/18

1.1 N5531S Measuring Receiver System Components

PSA spectrum analyzer and options¹

- Select a PSA platform based on the frequency coverage: E4443A (6.7 GHz), E4445A (13.2 GHz), E4440A (26.5 GHz), E4447A (42.98 GHz), E4446A (44 GHz), or E4448A (50 GHz)
- Option 233: built-in measuring receiver personality (required)
- Option 123: switchable μ W preselector bypass (required for measurements above 3 GHz)
- Option 1DS: RF preamplifier (required to meet the best TRFL specifications up to 3.05 GHz)² or Option 110: RF/ μ W internal preamplifier (required to meet the best TRFL specification at entire frequency range)
- Option 107: audio input 100 k Ω (required for audio analysis)
- Select from available PSA options for other measurement purpose (optional)

(Select one from the following models.)

P-Series power meter

- Select from available N1911A or N1912A options (optional)

EPM Series power meter

- Select from available N1913A or N1914A options (optional)

N5532B sensor module (select one frequency coverage) and N191xA power meter adaptor

- Option 504: (100 kHz to 4.2 GHz)
- Option 518: (10 MHz to 18 GHz)
- Option 526: (30 MHz to 26.5 GHz)
- Option 550: (30 MHz to 50 GHz)
- Option 019: adaptor for use with the N191xA power meter (required for connecting the sensor module to the P-Series power meter). This option can be ordered standalone.
- N5531S-010: LAN connection kit (required if an external PC is used)

1.2 Upgrade Kits

Upgrade kits for each of the required PSA options are available to upgrade existing customer units. The power meters require no additional options. The N5532B sensor modules can be purchased individually. Contact your local Keysight sales representative or access (http://www.keysight.com/find/psa_upgrades) for more information.

1. You can also select any other available PSA options if desired. Refer to the *Keysight PSA Series High-Performance Spectrum Analyzers Configuration Guide* 5989-2773EN for option compatibilities.
2. PSA options 1DS and 110 cannot coexist in a same PSA instrument. Option 1DS covers the frequency range of 100 kHz and 3.05 GHz, whereas Option 110 covers between 10 MHz and the maximum frequency of the PSA base instrument in use.

2.1 Demonstration Preparation

All demonstrations use the system setup shown in the Figure 2 on page 6. Keystrokes surrounded by [] indicate front panel hard keys. Keystrokes surrounded by { } indicate soft key on display. Keystrokes are referred to PSA unless otherwise indicated.

To perform the following demonstrations, the instruments included in the N5531S measuring receiver system require these options, indicated in Table 1.

Table 1. Requirements of a demo set-up

Product type	Model number	Required options
PSA Series spectrum analyzer Firmware version: A.11.21	E4443A/45A/40A/ 47A/46A/48A	Option 233 Built-in measuring spectrum receiver personality
		Option 123 Switchable μ W preselector bypass (required when measuring tuned RF level for freq > 3 GHz)
		Option 1DS RF preamplifier (required for the best level sensitivity between 100 kHz and 3.05 GHz),
		Or
		Option 110 RF/ μ W preamplifier (required for the best sensitivity between 10 MHz and the max. freq of PSA used)
		Option 107 Audio input 100 k Ω (required for audio measurements)
P-Series power meters Firmware version: A.05.02 or later	N1911A/12A	Standard features
EPM Series power meters Firmware version: A.01.06 or later		N1913A/N1914A Standard features
Sensor module	N5532B	Option 504 100 kHz to 4.2 GHz, or
		Option 518 10 MHz to 18 GHz, or
		Option 526 30 MHz to 26.5 GHz, or
		Option 550 30 MHz to 50 GHz
		Option 019 N191xA power meter adaptor (required)

2.2 Setup of the N5531S Measuring Receiver Demo System

Connect all the instruments together as shown in Figure 2. A Keysight ESG (E44xxC) is used as a device under test (DUT) for both RF and audio signals (LF out) generation. The PSA's time base is used as the common reference for both the PSA and ESG. To do this, connect a BNC cable from the "10 MHz out (Switched)" connector on the PSA rear panel to the "10 MHz in" connector on the ESG rear panel.

Data communications between the PSA and the power meter are based on the TCP/IP protocol though the local-area network (LAN). For the demonstrations without PC user interface, using a cross-over LAN cable is the simplest way to connect between the E444xA PSA and the N1911A P-Series power meter, establishing a stand-alone LAN environment. Additionally, a LAN hub with regular LAB cables can also be used.

PSA spectrum analyzer

With the LAN cable connected, turn the power on.

Verify the "Frequency reference"

- Press [System], then {Reference}
- Press {10 MHz Out} and make sure "On" is underlined.
- At this point, verify that the ESG displays "Ext Ref" to ensure that the ESG is phase-locked to the PSA.

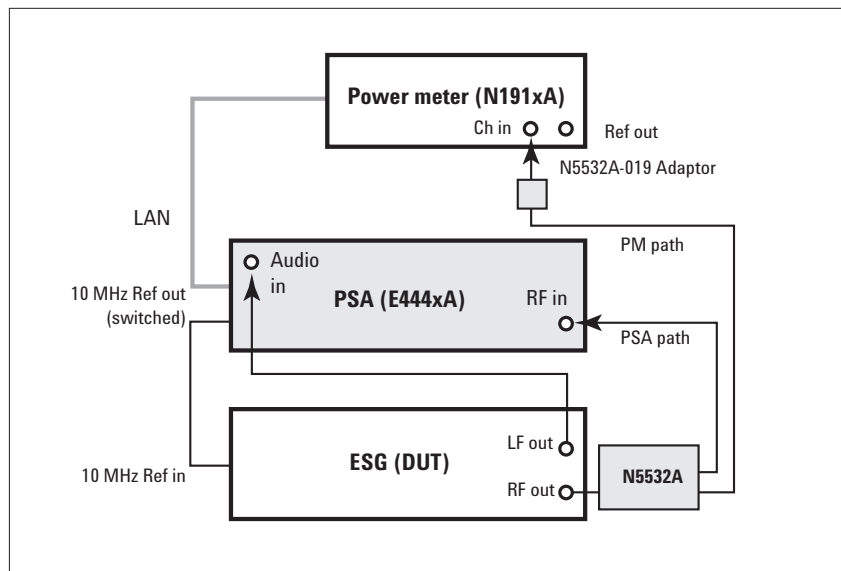

Figure 2. Demonstration System Setup

Establish the LAN communication between PSA and P-Series power meter (An example for using a cross-over LAN)

- Power meter: Press [System], {Remote Interface}, {Network Manual}. With the first IP address box highlighted; press [Select], [192], {Enter}; Press [▶] to highlight the second IP address box, press [Select], [168], {Enter}; Press [▶] to highlight the third IP address box, press [Select], [100], {Enter}; Press [▶] to highlight the last IP address box, press

2.2 Setup of the N5531S Measuring Receiver Demo System (Continued)

[Select], [2], [Enter]. In this way, the IP address of the power meter is set up as "192.168.100.2". Similarly, one can set up the "Subnet mask" of the power meter as "255.255.255.0". Press [Restart Network] to enable the new settings.

- PSA: Press [System], {Config I/O}, {IP Address}, [192.168.100.1], [Enter] to set up the PSA's IP address as "192.168.100.1". Press {Subnet mask}, [255.255.255.0], [Enter] to set the PSA's Subnet mask as "255.255.255.0".
- PSA: Press [System], {More 1 of 3}, {More 2 of 3}, {Power Meter}, {Power Meter Config}, {Power Meter IP Address}, [192.168.100.2], [Enter]. Then, press {Verify Power Meter Connection}, the grayed-out {Show Setup} should become available if the connection between the PSA and the P-Series power meter is established. Press {Show Setup} to verify the power meter information.

Load the N5532B sensor module cal factors

- PSA: Press [MODE], {Measuring Receiver}, [File], {Load}, {Type}, {More 1 of 2}, {Calibration Factor}. Insert the 3" floppy disk of the "N5532B sensor module data disk" into the PSA's floppy driver, and press {Dir Up}, [↑], {Dir Select} to ensure the "A" drive is selected. Then, press {Load Now} to load the cal factor file (CFDATA.XML) to the PSA.

Calibration of the power meter and the PSA

As the N5531S is used by metrology labs to calibrate signal generators and/or attenuators; achieving the best measurement accuracy and precision is of paramount importance. To ensure accurate measurements, the power meter and the PSA must first be calibrated by following the procedures below.

Calibrate the PSA:

- Press [System], {Alignments}, {Align All Now}, and wait until its completion.

Calibrate the power meter:

- Connect the RF input connector of the sensor module N5532B to the power meter's Ref connector
- On PSA: press [System], {More 1 of 3}, {More 2 of 3}, {Power Meter}, {Zero & Cal Power Meter}, and wait until its completion.

Or:

- On the Power meter: press [Cal], {Zero+Cal}, and wait until its completion.

Upon completion of the calibration, connect the RF input connector of the sensor module to the RF output of the ESG (DUT) for measurements. Connect the SA path and power meter path of the sensor module to the PSA "RF input" and the power meter "Channel in", respectively.

ESG signal generator

Set the signal generator to 1.1 GHz and -10 dBm:

- [Freq] = [1.1] {GHz}
- [Amplitude] = [+/-] [10] {dBm}
- [Incr Set], [10] {dB}
- [RF ON]
- [MOD OFF]

Save the ESG setting in preset:

- [Utility], {Preset} to highlight "User", {Save User preset}

3. The N5531S Measuring Receiver Demonstration

Measurement 1: Frequency Counter

Frequency is one of the most fundamental measurements performed on all signal generators that generate sinusoidal continuous wave (CW) RF outputs. The Keysight PSA Series high performance spectrum analyzer offers outstanding frequency accuracy, resolution power and measurement sensitivity, and hence warrants the accuracy and precision of the frequency measurements using the N5531S. The PSA automatically tunes to and measures the frequency of carrier signals. The frequency counter automatically adjusts itself as the input level changes.

Additionally, if the nominal frequency of the signal under test is known, the measuring receiver can be manually tuned to that frequency and make accurate measurements. The manual tune is particularly useful if the signal level is so low that the automatic tune fails to find the signal. The manual tuning also allows faster measurements when the frequency of the input signal is much higher than 100 MHz.

Note: Please make sure that the modulation of the ESG is "Off" when making "Frequency Counter" measurements.

Instructions	Keystrokes
Initiate the "Measuring Receiver" personality.	[MODE], {Measuring Receiver}
Start "Frequency Counter" measurement in "Auto Tuning" mode.	[MEASURE], {Frequency Counter}
Ensure "Auto Tuning" mode is set.	[Meas Setup], press {Tuning} to underline "Auto"
Set the displayed unit to "GHz".	[AMPLITUDE], {Display Unit}, {GHz}
Change "Frequency Counter" measurement to "Manual tuning" mode.	[Meas Setup], press {Tuning} to underline "Man"
Observe the frequency counter measurement result on the PSA screen.	
Set the nominal frequency (1.1 GHz, for example) manually.	{Tuning}, [1.1], {GHz}
Observe the display on the PSA screen for the frequency reading and frequency error reading (the difference between the measured frequency and the nominal one).	

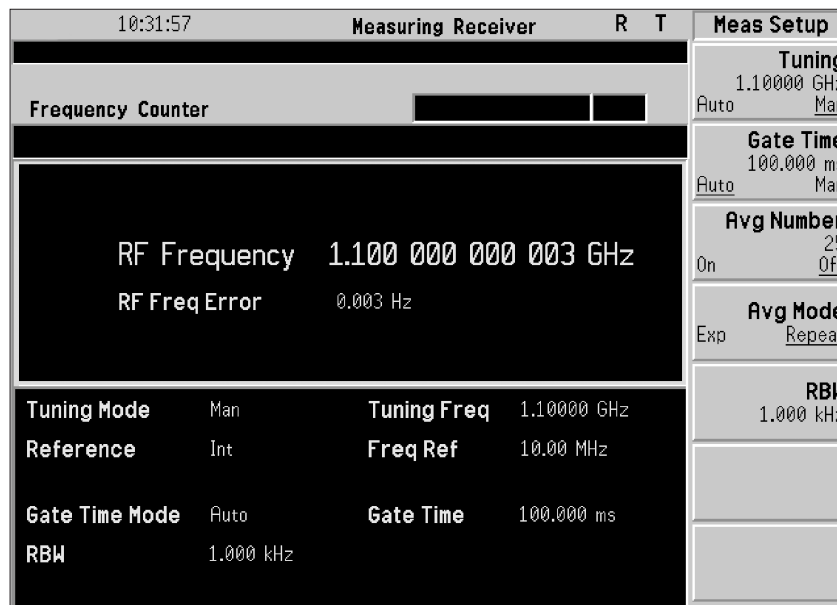

Figure 3. "Frequency counter" measurement result

3. The N5531S Measuring Receiver Demonstration (Continued)

Measurement 2: RF Power

The “RF Power” quantifies the output level, in an absolute term, of a signal generator or an attenuator being calibrated. This is another common measurement for broadband RF signal qualification. The measurement default is to use a power meter with a sensor module to make the RF power measurement. The power meter measures the RF power and returns the result to the PSA. The extraordinary power accuracy and wide frequency range offered by the Keysight N191xA P-Series/EPM Series power meter that is part of the N5531S measuring receiver system provide users the confidence they need in making their absolute RF power measurements.

Instructions	Keystrokes
Start “RF Power” measurement.	[MEASURE], {RF Power}
Set the displayed unit to “Watt”.	[AMPLITUDE], {Display Unit}, {Watt}
Change back to “dBm”.	{dBm}
Change the number of averaging (the averaging is defaulted as “Off”).	[Meas Setup], press {Avg Number} to underline “On”
Select mode of averaging to “Exponential” or “Repeated” as needed ¹ .	[Meas Setup], press {Avg Mode} to underline “Exp” or “Repeat”



Figure 4. “RF power” measurement result

1. In the “Repeated” mode, the averaging is reset and a new average is started after the average count is reached. By contrast, in the “Exponential” mode, each successive data acquisition after the average count is reached, is exponentially weighted and combined with the existing average.

3. The N5531S Measuring Receiver Demonstration (Continued)

Measurement 3: Tuned RF Level (TRFL)

The TRFL test is used to make power measurements with exceptional accuracy and sensitivity. Unlike the “RF Power” measurement, which measures total power across a wide frequency band, the TRFL measurement tunes the PSA to the frequency of interest with a very narrow resolution bandwidth (RBW) setting so that an extremely low level of power can be measured within measurement uncertainties demanded by the metrology and calibration customers.

Note: When making TRFL measurements, optimal measurement accuracy and speed is obtained by setting the frequency on the PSA directly using the [FREQUENCY Channel] (do not use the frequency counter).

Measurement 3a: Absolute TRFL measurement

The absolute TRFL is particularly useful when calibrating signal generators for their RF output at absolute terms. At an initial high input power level (for example at 0 dBm), the power measurement is performed with the high-precision power meter. The measurement result with the power meter is taken as a reference, then the PSA is tuned to the frequency of the signal-under-test and set to a narrow IF bandwidth to deliver accurate measurements for the input power levels, stepping down to the minimum of -140 dBm.

Instructions	Keystrokes
Manually tune to the frequency of the input signal (1.1 GHz)	[FREQUENCY], {Center Freq}, [1.1], {GHz}
Set RF out of ESG to 0 dBm as the initial power level.	On ESG: [Preset], [AMPLITUDE], [0], {dBm}
Start “TRFL” measurement.	[MEASURE], press {Tuned RF Level}
Compare readings from the power meter and from the PSA “TRFL” display.	
Decrease the RF output of the ESG by 10 dB/step to -130 dBm. Get TRFL readings after every change in the ESG output level.	On ESG: [AMPLITUDE], [down arrow]
Read values for the “Rang2 Switch Level” and “Range3 Switch Level” on the PSA display. Slowly step down the ESG output level around those switch level values to ensure the range-to-range recalibrations are complete.	
Reset TRFL cal factors.	[Preset]
The IF BW is defaulted to 10 Hz. Adjust it to 75 Hz. This speeds up the TRFL measurement by trading off sensitivity. Furthermore, selecting IF BW of 30 kHz or 200 kHz can accommodate the TRFL tests for the signals with less frequency stability.	[Meas Setup], press {IF BW}, {75 Hz}
The accuracy is defaulted to “Normal”. Adjust it to “High” to meet the most stringent accuracy specs at the cost of measurement speed.	[Meas Setup], press {Accuracy} to underline “High”

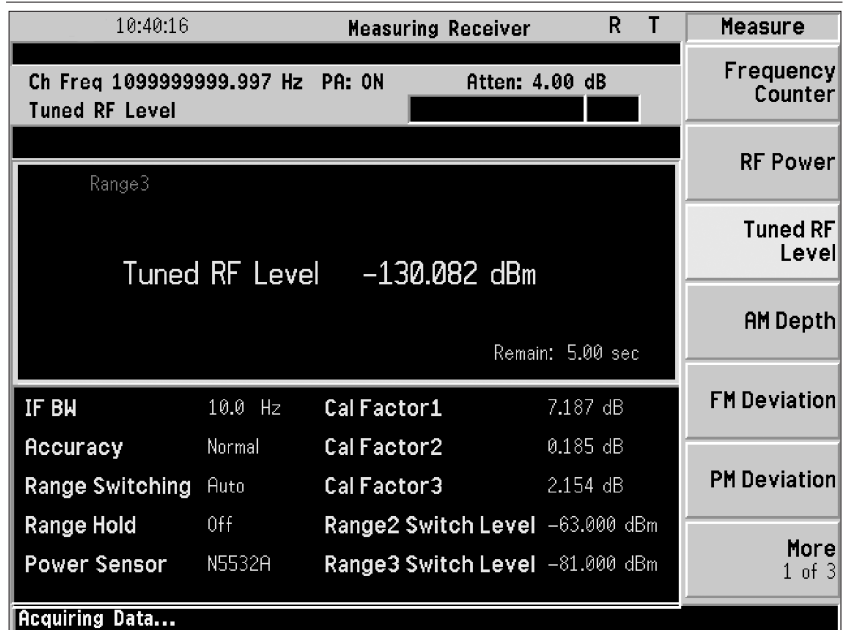

Figure 5a. Absolute “TRFL” measurement result at -130 dBm

3. The N5531S Measuring Receiver Demonstration (Continued)

Measurement 3b: Relative TRFL measurement

Differing from the absolute TRFL measurement, the relative TRFL measurement sets the first power measurement to 0 dB and measures the succeeding input power levels in relative terms (dB or %). This measurement is widely used in the step attenuator calibrations to verify the linearity and step accuracy of step attenuators. Measurement uncertainty specifications for the relative TRFL measurement are so exceptionally stringent that any disturbance in the measurement environment may result in extra uncertainties. Therefore, in order to achieve the best possible measurement results, the best practice metrological procedure must be followed when making the relative TRFL measurement.

Measurement 3c. TRFL with tracking

This new feature provides satisfying calibrations for signal sources with frequency instability greater than 100 kHz. Once enabled, this feature allows the measuring receiver to track the drifting signal with trade-off of the sensitivity and accuracy. The “TRFL with Tracking” is under “MODE” menu. Press [MODE], {More} and {Mode} to find it.

Note: A power meter and a sensor module are required to make an “absolute” TRFL measurement. The power meter provides the initial absolute power reference for the PSA. Alternatively, a relative TRFL measurement can be made without a power meter.

Instructions	Keystrokes
Preset the ESG and set the ESG output to +10 dBm.	On ESG, [Preset], [AMPLITUDE], [10], {dBm}
Turn on “TRFL” measurement.	[MEASURE], {Tuned RF Level}
Manually tune to the frequency of the input (1.1 GHz). While the auto-tuning is also available, it may take time for the hardware to settle down. To achieve the best possible accuracy, manual tuning for the TRFL is required.	[FREQUENCY], {Center Freq}, [1.1] {GHz} signal
The accuracy mode defaults to “Normal”. Adjust it to “High” to meet the most stringent accuracy specifications.	[Meas Setup], {Accuracy} to underline “High”
Restart the TRFL measurement.	[Restart]
Set the first measurement result as reference (0 dB).	[Meas Setup], {Set Ref}
Step down the RF output level at 10 dB per step to the minimum power level of the ESG.	On ESG, [Amplitude], keep pressing [down arrow] in –10 dB increments down to –130-dBm output (–140 dB from the +10 dBm) and watch the displayed TRFL results. <i>Caution: around the “Range Switch Levels” whose values are indicated on the PSA display, you need to slow down the changing of the RF output to ensure the “Range change recalibrations” are complete.</i>

The IF BW is defaulted to 10 Hz for the higher sensitivity. Adjust it to 75 Hz to speed up the measurements by trading off sensitivity. Furthermore, selecting IF BW of 30 kHz or 200 kHz can accommodate the TRFL tests for the signals with less frequency stability.

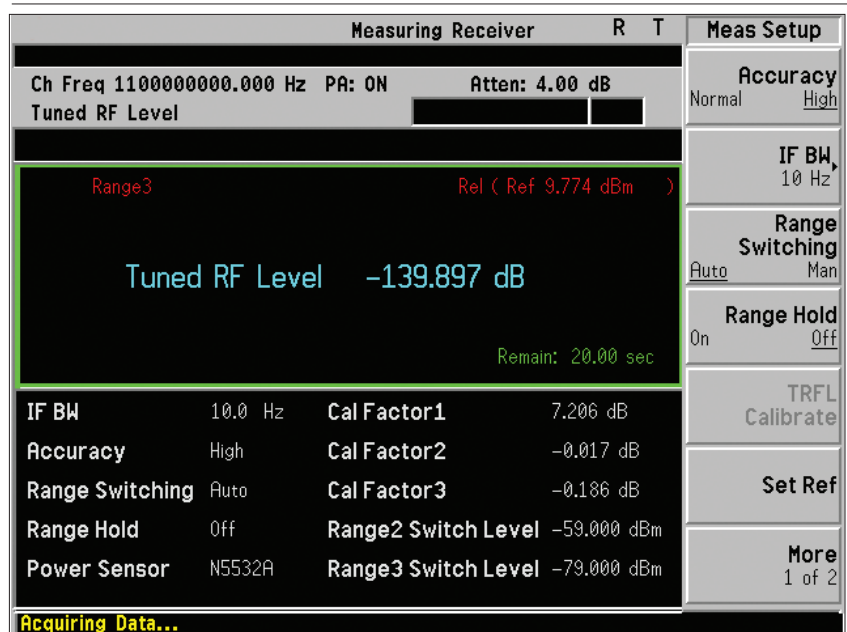

Figure 5b. Relative TRFL measurement result for –140 dB relative power level change

3. The N5531S Measuring Receiver Demonstration (Continued)

Measurement 4: AM Analysis

Amplitude modulation (AM) of a sine or cosine carrier results in a variation of the carrier amplitude that is proportional to the amplitude of the modulating signal that contains information. Amplitude modulation is a linear process. The modulating signal varies the amplitude of the resultant modulated signal, therefore, adds power to the carrier.

4.1 AM depth

The AM depth is the amount of amplitude modulation. It ranges from 0% to 100%. The following modulation index (m) defines the AM depth:

In time domain:

$$m = (E_{\max} - E_{\min}) / (E_{\max} + E_{\min}) \text{ (in \%)},$$

where, E_{\max} and E_{\min} are the maximum and minimum amplitudes (in voltage) of the modulated signal.

AM depth can be described either in a linear term (%) or in a logarithmic term (dB). Both terms are related as follows:

$$\text{AM depth (in dB)} = 20 \times \log(m)$$

The peak detector is used for the AM depth measurement. Using the RMS detector may introduce errors. When the modulating signal (or base band signal) is asymmetric, using +peak or -peak detector will generate different measurement results, and the \pm peak/2 detector is recommended. A waveform view is provided for a more intuitive presentation of the AM depth variation versus time for the demodulated signal.

4.2 AM modulation rates and modulation distortion

The AM modulation rate implies the frequency of the modulating signal. The modulation distortion for the AM is the undesired alterations to the modulated signal added by the modulation processes. The modulation distortion is defined as the ratio of the total unwanted

Instructions	Keystrokes
Reset the signal generator.	On ESG: [Preset]
Set 10% of the AM depth.	On ESG: [AM], [AM Depth], [10] {%}
Set 400 Hz of AM rate.	On ESG: {AM Rate}, [400], {Hz}
Turn on AM modulation.	On ESG: press {AM Off/On} to highlight "On"
Make sure the indicator on the ESG display reads "MOD ON".	On ESG: press [Mod On/Off] to highlight "On"
To get faster measurements, the user may want to band-limit the signal using a combination of a high-pass (HPF) and a low-pass filter (LPF). Since a 400 Hz AM signal will be examined in this example, a 50 Hz HPF and a 3 kHz LPF will be selected.	[Det/Demod], {HP Pass Filter}, {50 Hz}, {LP Pass Filter}, {3 kHz}
Start AM analysis.	[MEASURE], {AM Depth}
Watch the readings for AM depth, modulation rate, distortion, and SINAD.	
Display waveform of the demodulated signal.	[Trace/View], {Demod Waveform}
Adjust the display Y scale.	[AMPLITUDE Y Scale], {Scale/Div}, [2.5], {%}
Adjust the display X scale.	[SPAN X Scale], [1] {ms}, you should see four cycles of the demodulated signal.
Modulation rate, modulation distortion, or modulation SINAD can also be measured separately.	[MEASURE], {More 1 of 3}, {Modulation Rate}, {Modulation Distortion}, or {Modulation SINAD}
Turn on "Fast Mode" to speed up measurements.	[Meas Setup], {More 1 of 2}, toggle {Fast Mode} to underline "On"

3. The N5531S Measuring Receiver Demonstration (Continued)

signals to the total signal:

Modulation distortion (in %) =

$$\frac{\sqrt{E_{total}^2 - E_{signal}^2}}{E_{total}}$$

where, E_{total} is the level of the total signal and E_{signal} is the level of the wanted modulating signal (in voltage). The term $\sqrt{E_{total}^2 - E_{signal}^2}$ implies the total unwanted signals which include harmonic distortion and noise.

These measurements verify the AM quality of the signal from the DUT.

4.3 AM modulation SINAD

Modulation SINAD is defined as the ratio of the total signal power to unwanted signal (harmonics and distortion):

Modulation SINAD (in % dB)=

$$=20 \times \log \left(\frac{E_{total}}{\sqrt{E_{total}^2 - E_{signal}^2}} \right)$$

This is another way to quantify the quality of the modulation process. See instructions/keystrokes on page 12.

4.4 Auto carrier trigger

This feature becomes available if Option 23A¹ is activated. See FM section for details.

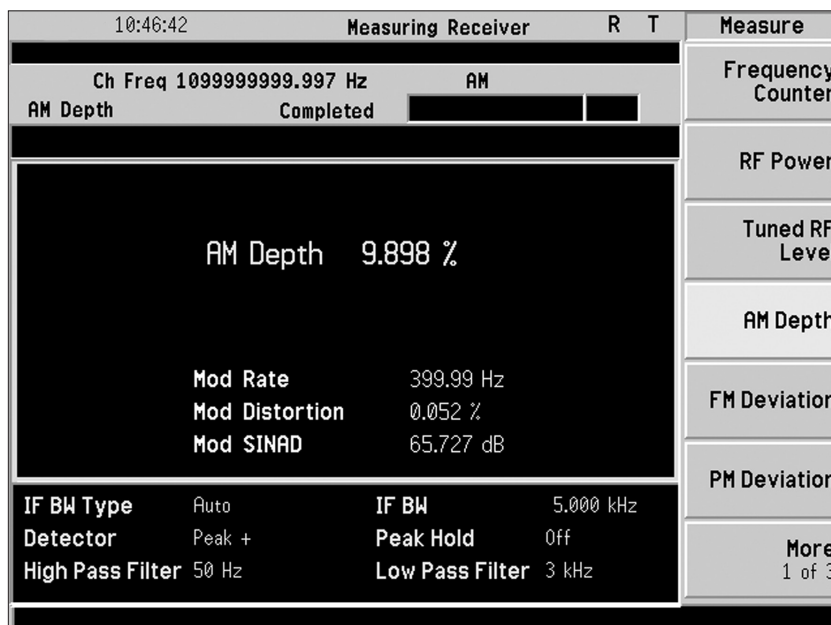

Figure 6. "AM modulation" result displayed in numerical format

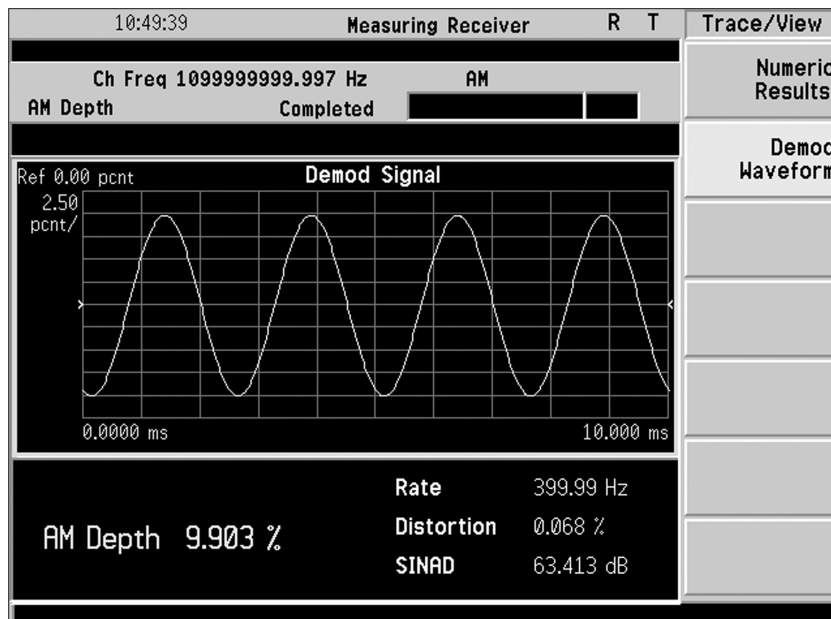

Figure 7. "AM modulation" result displayed in waveform

1. Option 23A is standard for PSA firmware rev. A.11.08 or later.

3. The N5531S Measuring Receiver Demonstration (Continued)

Measurement 5: FM Analysis

Frequency modulation (FM) is a scheme of angular (or exponential) modulation in which the modulating signal is used to vary the frequency of a carrier wave. The instantaneous frequency of the modulated carrier is directly proportional to the instantaneous amplitude of the modulating signal.

5.1 FM deviation

The FM deviation quantifies the amount of the frequency modulation. The quantity being measured is the peak frequency deviation that is the maximum frequency excursion from the average carrier frequency. In a signal generator calibration, a measuring receiver system must accurately measure the peak frequency deviation of the modulated signals to validate the given nominal values. The peak detector is used for accurate FM deviation measurements.

A waveform view displays the demodulated signal by showing the curve of FM deviation versus time, providing an intuitive picture for the quality of FM.

A series of filters (high-pass or low-pass) are provided for pre-conditioning the signal under test to achieve the best measurement results. For FM measurements, in particular,

four different “FM De-Emphasis” filters with different time-constants are also offered for analyzing the pre-emphasized FM signals.

Instructions	Keystrokes
Reset the signal generator.	On ESG: Press [Preset]
Set 1 kHz of FM deviation.	On ESG: Press [FM/ΦM], {FM Deviation}, [1] {kHz}
Set 400 Hz of FM rate.	On ESG: press {FM Rate}, [400], {Hz}
Turn on FM modulation.	On ESG: Press {FM Off/On} to highlight “On”
Make sure the indicator on the ESG display should read "MOD ON".	On ESG: Press [Mod On/Off] to highlight “On”
To get faster measurements, band-limit the signal using a combination of a high-pass (HPF) and a low-pass filter (LPF). In this case, select a 50 Hz HPF and a 3 kHz LPF.	Press [Det/Demod], {HP Pass Filter}, {50 Hz}, {LP Pass Filter}, {3 kHz}
Start FM analysis.	Press [MEASURE], {FM Deviation}
Watch the readings for FM deviation, modulation rate, distortion, and SINAD.	
Display waveform of the demodulated signal	Press [Trace/View], {Demod Waveform}
Adjust the display Y scale.	Press [AMPLITUDE Y Scale], {Scale/Div}, [250] {Hz}
Adjust the display X scale.	Press [SPAN X Scale], [2.5], {ms}, you should see 10 cycles of the demodulated signal
Modulation rate, modulation distortion, or modulation SINAD can also be measured separately.	Press [MEASURE], {More 1 of 3}, {Modulation Rate}, {Modulation Distortion}, or {Modulation SINAD}
Turn on “Fast Mode” to speed up measurements.	[Meas Setup], {More 1 of 2}, toggle {Fast Mode} to underline “On”

5.2 FM modulation rate and

3. The N5531S Measuring Receiver Demonstration (Continued)

modulation distortion

The FM modulation rate indicates frequency of the modulating signal. When the frequency of the modulating signal (or base-band signal) increases, the highest and lowest frequencies of the modulated signal will stay the same but occur more often.

Similar to that in AM, the modulation distortion for FM is measured on the post-detection signal (or base-band signal), and is defined as a ratio of the total harmonic distortion plus noise (THD+N) to the total signal level. These parameters quantify the signal distortion created during the FM modulation process in relative term.

5.3 FM modulation SINAD

Similar to AM analysis, another way to characterize the quality of FM is to use Modulation SINAD, which is defined as the ratio of the total signal level vs. unwanted signal (harmonics and distortion) level. See instructions/keystrokes on page 14.

10:53:10		Measuring Receiver		R	T	Measure
Ch Freq 1099999999.997 Hz		FM				Frequency Counter
FM Deviation		Completed				
FM Deviation 1000.72 Hz						RF Power
Mod Rate 399.99 Hz						Tuned RF Level
Mod Distortion 0.492 %						AM Depth
Mod SINAD 46.164 dB						FM Deviation
IF BW Type	Auto	IF BW	10.986 kHz			PM Deviation
Detector	Peak +	Peak Hold	Off			
FM De-Emphasis	None	Low Pass Filter	3 kHz			
High Pass Filter	50 Hz					More 1 of 3

Figure 8. "FM modulation" result displayed in numerical format

3. The N5531S Measuring Receiver Demonstration (Continued)

5.4 Auto carrier trigger

The auto carrier trigger feature is used to determine the settling time when a carrier signal changes from one frequency to another. The similar procedure listed here is also applicable to AM and PM as well. Users can set the capture time and different trigger type.

Additionally, this feature provides "Auto Carrier Frequency" to FM or PM modulation analysis. Accurate angular demodulation (FM or PM) analysis depends on precisely identifying the carrier frequency. Errors result in phase ramping. The goal of "Auto Carrier Frequency" is to correct the phase ramping by calculating the carrier frequency precisely.

*This is based on a direct connection between the PSA and the ESG signal generator. If an N5532B sensor module is used, it is recommended to increase the ESG RF output level to 0 dBm to ensure the sufficient triggering level.

Instructions	Keystrokes
Set RF out of ESG to -10 dBm for the carrier signal level, and set frequency to GHz and {MHz} frequency increment to 300 MHz.	On ESG: [Preset], [Amplitude], [-10] {dBm}, [Frequency], [1.3] {GHz}, [Incr Set], [300] 1.3
Start "FM deviation" measurement.	[MEASURE], press {FM Deviation}
Set PSA triggering level to -15 dBm*.	[Trig] {Video} {Level} [+/-] [15] {dBm}
Set measurement conditions for the auto carrier trigger.	[Meas Setup], toggle {IF BW Type} to underline "Man", {IF BW}, [100] {kHz}, {Trig Source}, {Video}, {Capture Time}, [100] {ms}
Set PSA center frequency to 1 GHz.	[FREQUENCY] {Center Freq}, [1] {GHz}
Display in waveform.	[Trace/View], {Demod Waveform}
Adjust the Y Scale.	[AMPLITUDE Y Scale], {Scale/Div}, [1], {kHz}
Adjust the X Scale.	[SPAN X Scale], {Scale/Div}, [1], {ms}
Measure the settling time when the carrier frequency changes from 1.3 GHz to 1 GHz.	While the prompt of "Awaiting Trigger, no Auto Trig" is shown at the bottom of the PSA screen, press [down arrow] on the ESG to change the ESG output frequency from 1.3 GHz to 1 GHz. Wait until the measurement is complete.

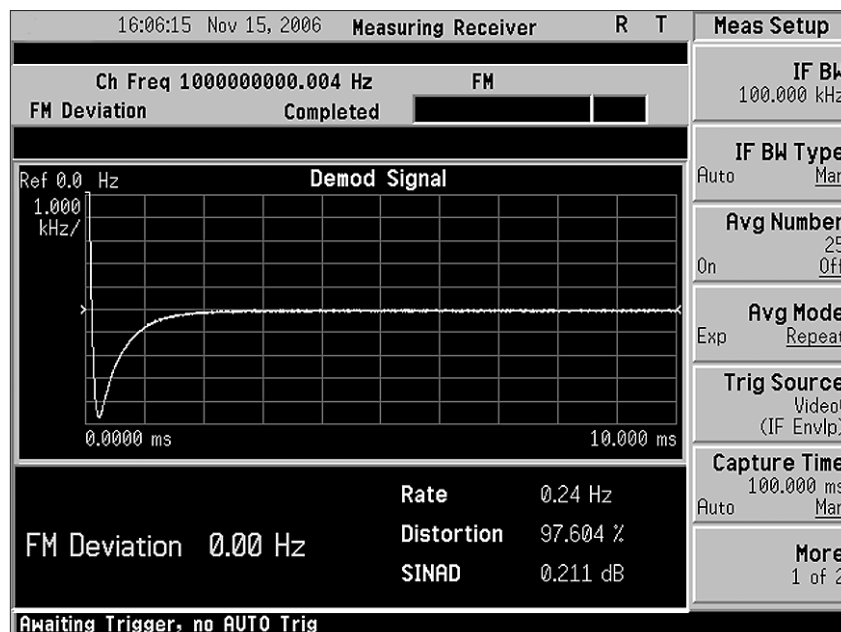

Figure 9. Auto carrier trigger showing the settling time for a changing carrier frequency

3. The N5531S Measuring Receiver Demonstration (Continued)

Measurement 6: Phase Modulation Analysis

Phase modulation (Φ M) is another form of angular (exponential) modulation in which the instantaneous phase deviation of the modulated carrier is directly proportional to the instantaneous amplitude of the modulating signal. Φ M and FM are very closely related, as phase is the time integral of the frequency or frequency is the time derivative of the phase.

6.1 Phase deviation

The phase deviation, or Φ M deviation, expressed in radians or in degrees, is a measure of the amount of phase modulation. The quantity being measured is the peak phase deviation, which is the maximum phase excursion from the average carrier phase.

A waveform view of the Φ M deviation measurements provides graphical displays of the demodulated signal by showing the curve of Φ M deviation versus time.

6.2 Phase modulation rate and modulation distortion

The Φ M modulation rate also indicates the frequency of the modulating signal. Increasing the frequency of the modulating signal will not alter the Φ M deviation, but will make faster phase alterations in the modulated signal.

Like the FM modulation distortion, the phase modulation distortion is also defined at the post-detection stage with the base-band signal. The modulation distortion is the ratio of

the total harmonic components plus noise to the level of the demodulated signal, i.e., the total undesired signal level to desired signal level.

Instructions	Keystrokes
Reset the signal generator.	On ESG: Press [Preset]
Set 0.5 rad of Φ M deviation.	On ESG: Press [FM/ Φ M], { Φ M Dev}, [0.5] {rad}
Set 400 Hz of Φ M rate.	On ESG: Press { Φ M Rate}, [400], {Hz}
Turn on Φ M modulation.	On ESG: Press { Φ M Off/On} to highlight "On"
Make sure the indicator on the ESG display reads "MOD ON".	On ESG: Press [Mod On/Off] to highlight "On"
To get faster measurements, band-limit the signal using a combination of a high-pass (HPF) and a low-pass filter (LPF). In this case, select a 50 Hz HPF and a 3 kHz LPF.	Press [Det/Demod], {HP Pass Filter}, {50 Hz}, {LP Pass Filter}, {3 kHz}
Start Φ M analysis.	Press [MEASURE], {PM Deviation}
Watch the readings for Φ M deviation, modulation rate, distortion, and SINAD.	
Display waveform of the demodulated signal.	Press [Trace/View], {Demod Waveform}
Adjust the display Y scale.	Press [AMPLITUDE Y Scale], {Scale/Div}, [0.25] {radians}
Adjust the display X scale.	Press [SPAN X Scale], [2.5], {ms}
	Note: You should see 10 cycles of the demodulated signal.
Modulation rate, modulation distortion, or modulation SINAD can also be measured separately.	Press [MEASURE], {More 1 of 3}, {Modulation Rate}, {Modulation Distortion}, or {Modulation SINAD}
Turn on "Fast Mode" to speed up measurements.	[Meas Setup], {More 1 of 2}, toggle {Fast Mode} to underline "On"

3. The N5531S Measuring Receiver Demonstration (Continued)

6.3 Phase modulation

SINAD

Similar to AM and FM, modulation SINAD can also be used to characterize the quality of the modulation of the signal. See instructions/keystrokes on page 17.

6.4 Auto carrier trigger

See FM section for details.

10:55:51		Measuring Receiver		R	T	Measure
Ch Freq 1099999999.997 Hz		PM				Frequency Counter
PM Deviation		Measuring				RF Power
PM Deviation 0.4998 rad						Tuned RF Level
Mod Rate 399.99 Hz						AM Depth
Mod Distortion 1.299 %						FM Deviation
Mod SINAD 37.728 dB						PM Deviation
IF BW Type	Auto	IF BW	10.986 kHz			More
Detector	Peak +	Peak Hold	Off			1 of 3
High Pass Filter	50 Hz	Low Pass Filter	3 kHz			

Figure 10. "Phase modulation" measurement result displayed in numerical format

3. The N5531S Measuring Receiver Demonstration (Continued)

Measurement 7: Audio Analysis

Audio analysis is only available when both the measuring receiver personality (Option 233) and audio input (Option 107) are installed in a PSA. Audio analysis is performed on the signal from a high-impedance audio input connector (100 kΩ) on the PSA front panel. The frequency range is 20 Hz to 250 kHz. Once any of the audio analysis related soft-keys (Audio Frequency, Audio AC Level, Audio Distortion, and Audio SINAD) is enabled, the input signal path is automatically switched from the RF input to the audio input.

7.1 Audio frequency

Audio frequency measurement accurately measures the frequency of audio signals or a demodulated signal from the audio input connector of the PSA (Option 107).

Instructions	Keystrokes
Set the LF out on the signal generator for generating audio signals.	On ESG: Press [LF Out], {LF Out Source}, {Function generator}
Set the amplitude of the audio signal to 1 Vp.	On ESG: Press {LF Out Amplitude}, [1] {Vp}
Set the frequency of the audio signal to 1 kHz.	On ESG: Press {LF Out Freq}, [1], {kHz}
Set the audio signal to sine wave.	On ESG: Press {LF Out Waveform}, {Sine}
Turn on audio signal output.	On ESG: Press {LF Out Off/On} to highlight "On". Press [Mod On/Off] and ensure modulation is "On"
To get faster measurements, band-limit the signal using a combination of a high-pass (HPF) and a low-pass filter (LPF). In this case, select a 300 Hz HPF and a 30 kHz LPF.	Press [Det/Demod], {HP Pass Filter}, {50 Hz}, {LP Pass Filter}, {3 kHz}
Start Audio Frequency measurement.	Press [MEASURE], {More 1 of 3}, {Audio Frequency}

Watch the readings for audio frequency in the display window.

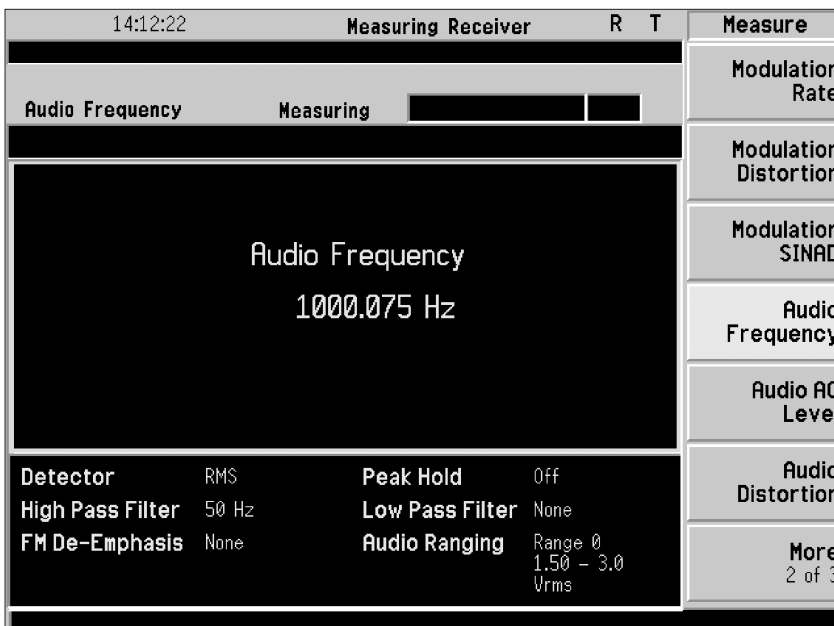

Figure 11. "Audio frequency" measurement result

3. The N5531S Measuring Receiver Demonstration (Continued)

7.2 Audio AC level

The audio AC level measurement is used to measure the average (rms) level of the input audio signal. The RMS detector is used for the audio AC level measurements. Absolute audio AC level measurement results are displayed in voltage unit. Additionally, relative results are displayed in dB or % of a reference level that can be manually set through the front panel of the PSA.

Instructions	Keystrokes
Set the LF out on the signal generator for generating audio signals.	On ESG: Press [LF Out]
Set the amplitude of the audio signal to 1 Vp.	On ESG: Press {LF Out Amplitude}, [1] {Vp}
Set the frequency of the audio signal to 1 kHz.	On ESG: Press {LF Out Freq}, [1], {kHz}
Set the audio signal to sine wave.	On ESG: Press {LF Out Waveform}, {Sine}
Turn on audio signal output.	On ESG: Press {LF Out Off/On} to highlight "On". Press [Mod On/Off] and ensure modulation is "On".
If needed, band-limit the signal using a Hz), combination of a high-pass (HPF) and a low-pass filter (LPF). In this case, we will select a 300 Hz HPF and a 30 kHz LPF.	Press [Det/Demod], {HP Pass Filter}, {50 {LP Pass Filter}, {3 kHz}
Start audio AC level measurement.	Press [MEASURE], {More 1 of 3}, {Audio AC Level}
Watch the readings for audio AC level in the display window.	
Set a relative measurement.	Press [Amplitude], then {Display Mode} to underline "Ratio"
Set a reference level of 1 Vrms.	Press [Amplitude], then {Ratio Ref} to underline "Man", [1], {V}
Set ratio mode to logarithm.	Press [Amplitude], then {Ratio Mode} to underline "Log"
Watch the relative measurement result in the display window.	

3. The N5531S Measuring Receiver Demonstration (Continued)

7.3 Audio distortion

This measurement is used to quantify the distortion of the audio signal in a relative term. The audio distortion is defined as the ratio of the total distortion, including total harmonics and noises, to the fundamental audio signal level. The audio distortion is defined in linear form as follows:

Audio distortion (in %) =

$$\frac{\sqrt{E_{total}^2 - E_{signal}^2}}{E_{total}} \times 100$$

where, E_{signal} and E_{total} are amplitude of wanted audio signal and the total signal (in voltage) respectively.

A CCITT filter is available as a standard feature of the measuring receiver personality for audio and post-modulation analysis. The CCITT weighting is to simulate the human hearing sensitivity and therefore is particularly useful for audio distortion measurements. This optional CCITT filter is also available for modulation analysis.

Instructions	Keystrokes
Set the LF out on the signal generator for generating audio signal.	On ESG: Press [LF Out]
Set the amplitude of the audio signal as 1 Vp.	On ESG: Press {LF Out Amplitude}, [1], {Vp}
Set the frequency of the audio signal as 1 kHz.	On ESG: Press {LF Out Freq}, [1], {kHz}
Set the audio signal as sine wave.	On ESG: Press {LF Out Waveform}, {Sine}
Turn on audio signal output.	On ESG: Press {LF Out Off/On} to highlight "On". Press [Mod On/Off] and ensure modulation is "On".
Start audio distortion measurement.	Press [MEASURE], {More 1 of 3}, {Audio Distortion}
Watch the readings for audio distortion in the display window.	
Turn on CCITT filter.	Press [Det/Demod], {Band Pass Filter}, {CCITT weighting}

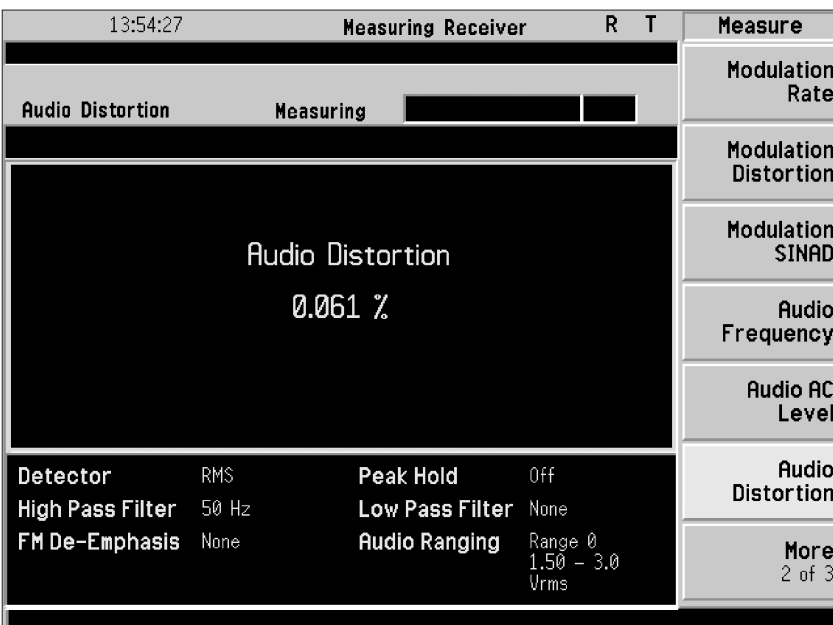

Figure 12. "Audio distortion" measurement result

3. The N5531S Measuring Receiver Demonstration (Continued)

7.3 Audio SINAD

In audio signal analysis, one of the most commonly used parameters to characterize the quality of an audio signal is audio SINAD. The audio SINAD is defined as the ratio of the fundamental audio signal level to the total harmonics and noise level (in voltage). The audio SINAD is often presented in logarithmic term as follows,

Audio SINAD (in dB)

$$= 20 \times \log \left(\frac{E_{\text{total}}}{\sqrt{E_{\text{total}}^2 - E_{\text{signal}}^2}} \right)$$

where, E_{signal} and E_{total} are amplitude of the wanted audio signal and the total signal (in voltage), respectively.

Instructions	Keystrokes
Set the LF out on the signal generator for generating audio signals.	On ESG: Press [LF Out]
Set the amplitude of the audio signal to 1 Vp.	On ESG: Press {LF Out Amplitude}, [1] {Vp}
Set the frequency of the audio signal to 1 kHz.	On ESG: Press {LF Out Freq}, [1], {kHz}
Set the audio signal to sine wave.	On ESG: Press {LF Out Waveform}, {Sine}
Turn on audio signal output.	On ESG: Press {LF Out Off/On} to highlight "On". Press [Mod On/Off] and ensure modulation is "On".
Start audio SINAD measurement.	Press [MEASURE], {More 1 of 3}, {More 2 of 3}, {Audio SINAD}
Watch the readings for audio SINAD in the display window.	
Turn on CCITT filter.	Press [Det/Demod], {Band Pass Filter}, {CCITT weighting}

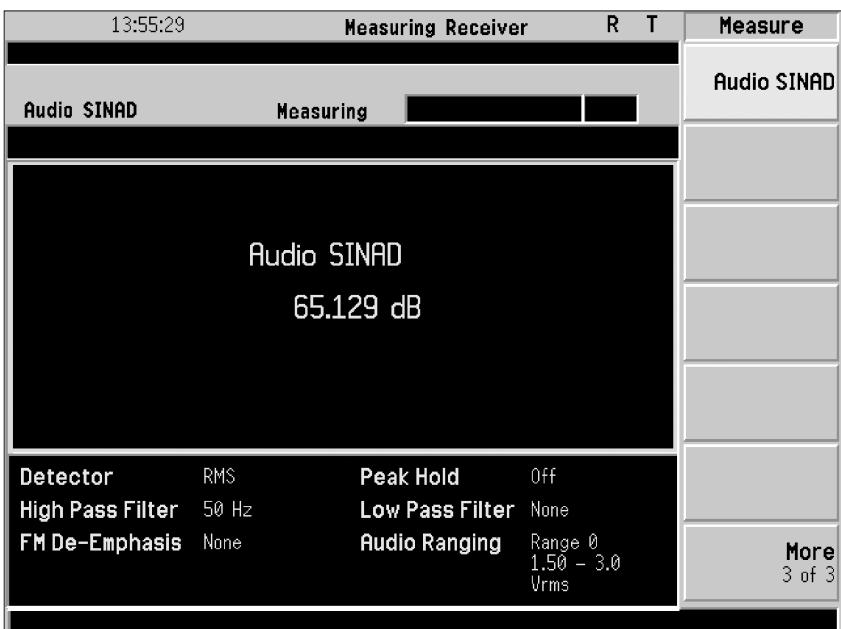

Figure 13. "Audio SINAD" measurement result

N5531S Ordering Information

The Keysight N5531S measuring receiver system is comprised of a PSA high-performance spectrum analyzer, a P-Series or EMP Series power meter, and an N5532B sensor module.

PSA Series spectrum analyzer

(Select one model from the following models)

- E4443A
3 Hz to 6.7 GHz
- E4445A
3 Hz to 13.2 GHz
- E4440A
3 Hz to 26.5 GHz
- E4447A
3 Hz to 42.98 GHz
- E4446A
3 Hz to 44 GHz
- E4448A
3 Hz to 50 GHz

PSA options (x = 0, 3, 5, 6, 7, 8)

E444xA-233
Built-in measuring receiver personality and PC software (required)

E444xA-123
Switchable μ W preselector bypass (required for TRFL measurements above 3 GHz)

E444xA-1DS
RF internal preamplifier (required for the best TRFL measurement sensitivity up to 3.05 GHz, does not co-exist with Option 110)

E444xA-110
RF/ μ W internal preamplifier (required for the best TRFL measurement sensitivity up to the upper frequency of PSA, does not co-exist with Option 1DS)

E444xA-107
Audio input 100 k Ω (required for audio analysis, only operational with Option 233)

AM/FM/PM triggering
Shipped standard with Option 233 (PSA firmware rev. \geq A.11.08) or Option 23A

CITT filter (adds CCITT and 400-Hz HP, 30-kHz/80-kHz LP filters)
Shipped standard with Option 233; (PSA firmware rev. \geq A.11.08) or Option 23B

Select from PSA options for other measurements (Optional, Refer to PSA Configuration Guide for details of option compatibility and requirements)

PSA option upgrades¹ (x = 0, 3, 5, 6, 7, 8)

E444xAU-233
Built-in measuring receiver personality and PC software (required)

E444xAU-123
Switchable μ W preselector bypass (required for TRFL measurements above 3 GHz)

E444xAU-1DS
RF internal preamplifier (required for the best TRFL measurement sensitivity up to 3.05 GHz, does not co-exist with Option 110)

E444xAU-110
RF/ μ W internal preamplifier (required for the best TRFL measurement sensitivity up to the upper frequency of PSA, does not co-exist with Option 1DS)

E444xAU-107
Audio input 100 k Ω (required for audio analysis, only operational with Option 233)

1. Upgrades for certain PSA options may not be available for earlier instruments. For detailed information regarding availability and compatibility of options, please visit:

http://www.keysight.com/find/psa_upgrades

N5531S Ordering Information (Continued)

(Select one from the following models)

P-Series power meter

N1911A
P-Series single channel power meter

N1912A
P-Series dual channel power meter

EPM Series power meter

N1913A
EPM Series single channel power meter

N1914A
EPM Series dual channel power meter

(optional)
Select from power meter options

N5532B sensor module

(Select one frequency option)

N5532B-504
100 kHz to 4.2 GHz, type N (m) input connector

N5532B-518
10 MHz to 18 GHz, type N (m) input connector

N5532B-526
30 MHz to 26.5 GHz, APC 3.5 (m) input connector

N5532B-550
30 MHz to 50 GHz, 2.4 mm (m) input connector

N5532B-019
Adaptor to N191xA power meter (required when the N191xA power meter is used), can also be ordered standalone

(optional)
Select from N5532B options

Accessories

N5531S-010

LAN connection kit (including one LAN hub and three regular LAN cables) (optional)

Note: For existing N5531S measuring receiver users who buy the N5532B sensor module to replace the N5532A:

Using the N5532B in place of the N5532A requires the following firmware versions:

- E444xA PSA: A.11.21
- N1911A power meter: A.05.02
- N1912A power meter: A.05.02
- N1913A power meter: A.01.06
- N1914A power meter: A.01.06

Related Literature

Publication title	Publication type	Publication number
N5531S measuring receiver		
<i>The Keysight N5531S Measuring Receiver</i>	Data Sheet	5989-9217EN
<i>Accurate Absolute and Relative Power Measurement Using the Keysight N5531S Measuring Receiver System</i>		Application Note 5989-8161EN
PSA in general		
<i>Selecting the Right Signal Analyzer for Your Needs</i>	Selection Guide	5968-3413E
<i>PSA Series</i>	Brochure	5980-1283E
<i>PSA Series</i>	Data Sheet	5980-1284E
<i>PSA Series</i>	Configuration Guide	5989-2773EN
<i>Self-Guided Demonstration for Spectrum Analysis</i>	Product Note	5988-0735EN
Power meter in general		
<i>P-Series Power Meters and Power Sensors</i>	Data Sheet	5989-2471EN
<i>P-Series Power Meters and Power Sensors</i>	Technical Overview	5989-1049EN
<i>EPM Series Power Meters</i>	Data Sheet	5990-4019EN
<i>EPM Series Power Meters</i>	Technical Overview	5990-4159EN
Power measurement fundamentals		
<i>Fundamentals of RF and Microwave Power Measurements, Introduction to Power, History, Definition, International Standards, and Traceability</i>	Application Note 1449-1	5988-9213EN
<i>Fundamentals of RF and Microwave Power Measurements, Power Sensors and Instrumentation</i>	Application Note 1449-2	5988-9214EN
<i>Fundamentals of RF and Microwave Power Measurements, Power Measurement Uncertainty per International Guides</i>	Application Note 1449-3	5988-9215EN
<i>Fundamentals of RF and Microwave Power Measurements, An Overview of Keysight Instrumentation for RF/Microwave Power Measurement</i>	Application Note 1449-4	5988-9216EN

myKeysight

myKeysight

www.keysight.com/find/mykeysight

A personalized view into the information most relevant to you.



www.axistandard.org

AdvancedTCA[®] Extensions for Instrumentation and Test (AXIe) is an open standard that extends the AdvancedTCA for general purpose and semiconductor test. Keysight is a founding member of the AXIe consortium. ATCA[®], AdvancedTCA[®], and the ATCA logo are registered US trademarks of the PCI Industrial Computer Manufacturers Group.



www.lxistandard.org

LAN eXtensions for Instruments puts the power of Ethernet and the Web inside your test systems. Keysight is a founding member of the LXI consortium.



www.pxisa.org

PCI eXtensions for Instrumentation (PXI) modular instrumentation delivers a rugged, PC-based high-performance measurement and automation system.



Three-Year Warranty

www.keysight.com/find/ThreeYearWarranty

Keysight's commitment to superior product quality and lower total cost of ownership. The only test and measurement company with three-year warranty standard on all instruments, worldwide.



Keysight Assurance Plans

www.keysight.com/find/AssurancePlans

Up to five years of protection and no budgetary surprises to ensure your instruments are operating to specification so you can rely on accurate measurements.



www.keysight.com/quality

Keysight Technologies, Inc.
DEKRA Certified ISO 9001:2008
Quality Management System

Keysight Channel Partners

www.keysight.com/find/channelpartners

Get the best of both worlds: Keysight's measurement expertise and product breadth, combined with channel partner convenience.

www.keysight.com/find/psa

For more information on Keysight Technologies' products, applications or services, please contact your local Keysight office. The complete list is available at: www.keysight.com/find/contactus

Americas

Canada	(877) 894 4414
Brazil	55 11 3351 7010
Mexico	001 800 254 2440
United States	(800) 829 4444

Asia Pacific

Australia	1 800 629 485
China	800 810 0189
Hong Kong	800 938 693
India	1 800 112 929
Japan	0120 (421) 345
Korea	080 769 0800
Malaysia	1 800 888 848
Singapore	1 800 375 8100
Taiwan	0800 047 866
Other AP Countries	(65) 6375 8100

Europe & Middle East

Austria	0800 001122
Belgium	0800 58580
Finland	0800 523252
France	0805 980333
Germany	0800 6270999
Ireland	1800 832700
Israel	1 809 343051
Italy	800 599100
Luxembourg	+32 800 58580
Netherlands	0800 0233200
Russia	8800 5009286
Spain	0800 000154
Sweden	0200 882255
Switzerland	0800 805353
	Opt. 1 (DE)
	Opt. 2 (FR)
	Opt. 3 (IT)
United Kingdom	0800 0260637

For other unlisted countries:
www.keysight.com/find/contactus
(BP-07-10-14)